



# Upgrading the firmware of the RX45X & RX55X MK4 (H8/3064F)



## Application Note How to install and use RENESAS Flash Development Toolkit



**Building Block Video Ltd.,**  
17 Apex Park,  
Diplocks Industrial Estate,  
Hailsham, East Sussex, BN27 3JU UK

Tel: +44(0)1323 842727  
Fax: +44(0)1323 842728  
Support: +44(0)1323 444600  
[www.bbvctv.com](http://www.bbvctv.com)



# Introduction

This application note gives step by step instructions on how to install & use RENESAS Flash Development Toolkit. It is important to look closely at each option when installing. This is also true when using the Toolkit update the firmware of the BBV product.

## Table of contents

Installing RENESAS Flash Development Toolkit.	4
Configuring RENESAS Flash Development Toolkit.	6
Selection of file to be used & Programming Flash	8
Connection Information & Location of Programming Link	9

# Installing RENESAS Flash Development Toolkit.

## How to install Flash Simple to your laptop:

### Step 1

Go to the BBV support website: [www.support.bbvctv.com](http://www.support.bbvctv.com)  
Click 'Software and Utils'  
Click 'New Version of Flash Simple' and save to your desktop  
Double click on 'fdtc401r00' zipped file on your desktop, then double click 'fdtv401r00' file when it opens.

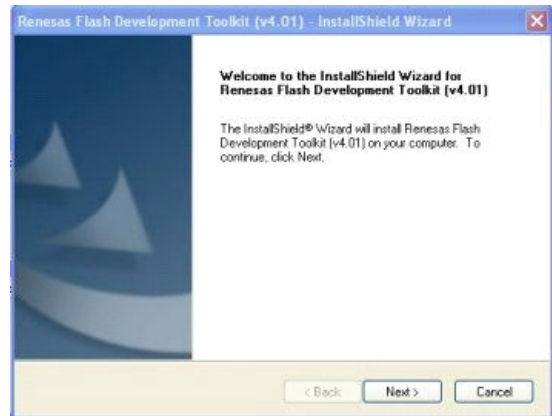

### Step 2 'Select Language'

Click 'Next'  
Then select the language and click 'Next'

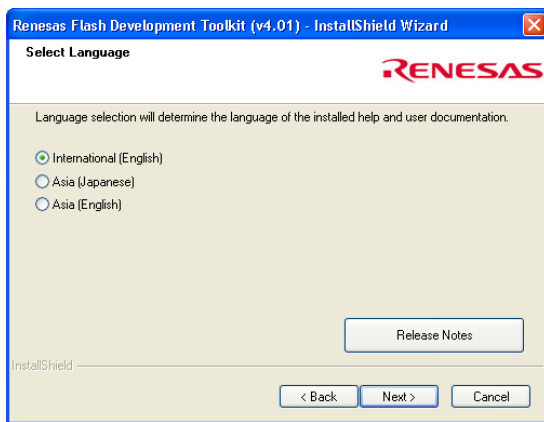

### Step 3 'Licence Agreement'

Read through the Licence Agreement and click on the appropriate box to confirm acceptance of the terms.

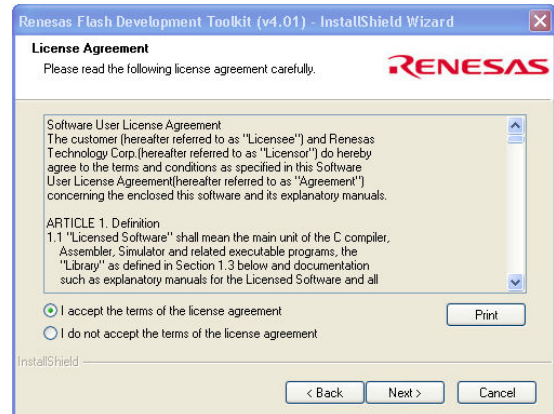

### Step 4 Select Features

All boxes should be ticked.  
Click 'Next'.

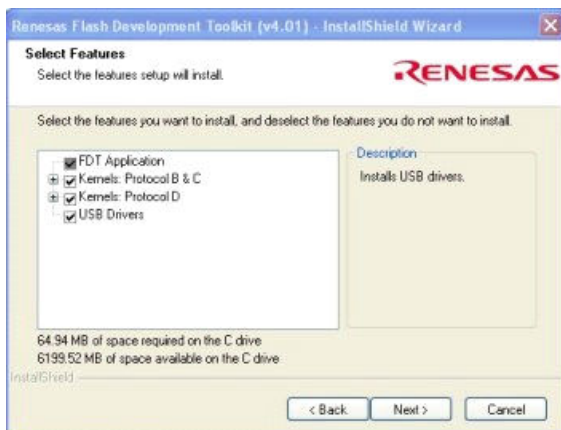

### Step 5 Select Options screen

All boxes should be ticked.  
Click 'Next'.

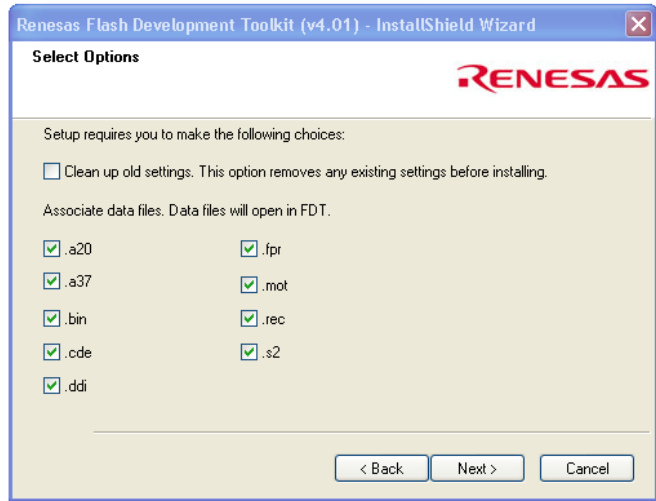

### Step 6 Choose Destination Location

This screen allows you to choose the location of the files. It is recommended they are saved in the default location: C:\Program Files\Renesas\FDT4.01

Click 'Next'

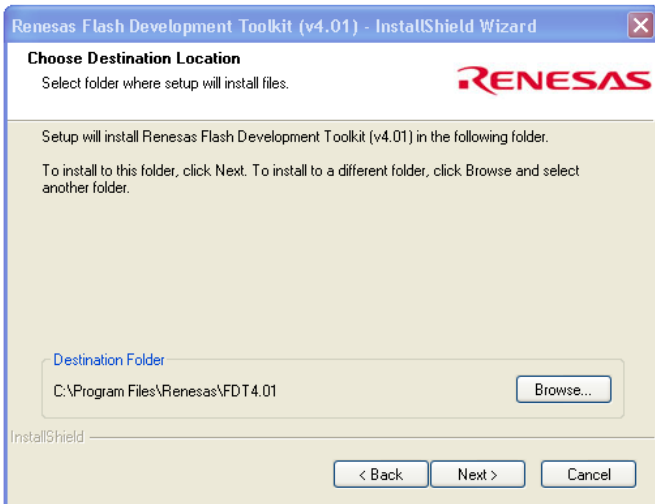

### Step 7 - Ready to install Program

Click 'Install'.

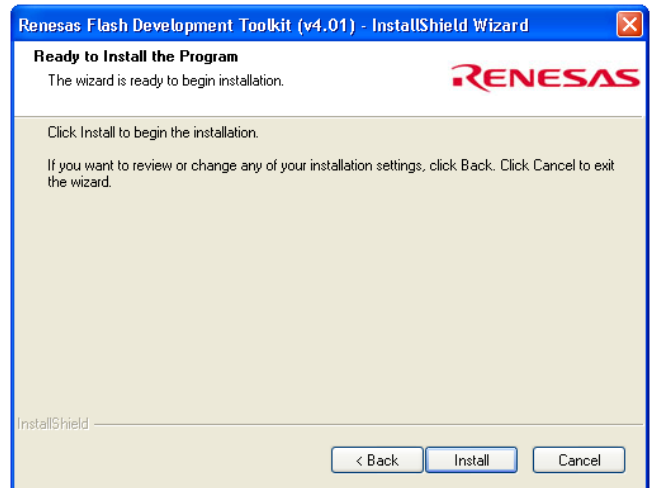

### Step 8 - Successfully Installed.

Once the install is complete you will see this screen. Click 'Finish'.

This window will now close.

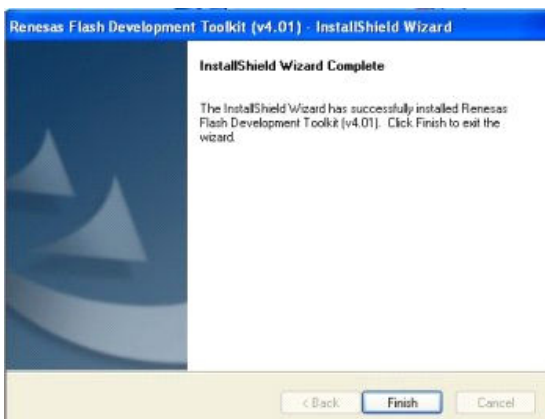

# Configuring RENESAS Flash Development Toolkit.



## Step 9

- Go to Start
- Click All Programs
- Click Renesas
- Click Flash Development Tools 4.01
- Click Flash Development Tools 4.01 Basic

## Step 10 Choose Device and Kernel

This screen will appear  
Select H8/3064F

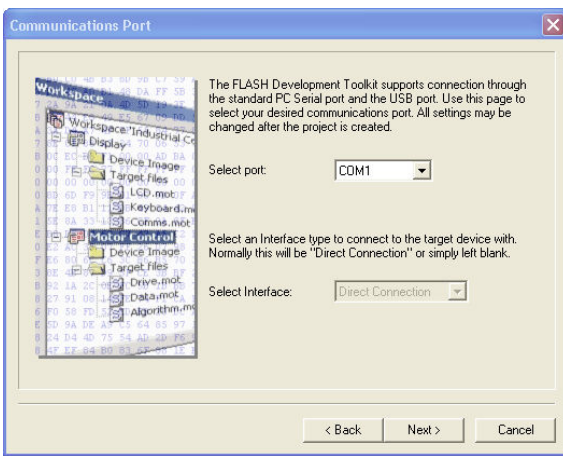
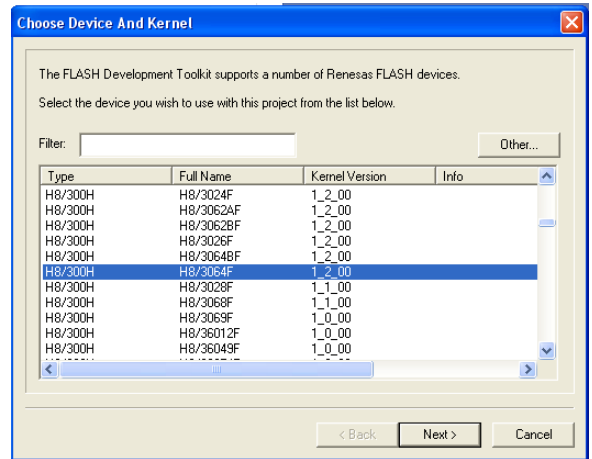

## Step 11 COM Port selection

The correct COM port is selected by using the drop down box. The correct COM port will depend on your PC.

Click 'Next' when the correct COM Port is selected.

## Step 12 Device Settings

Change the CPU crystal frequency to 16.000 Mhz  
Click 'Next'

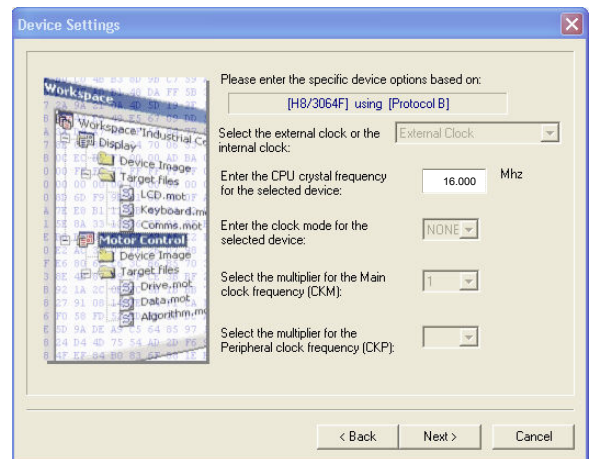

### Step 13 Connection Type

Click 'Next'

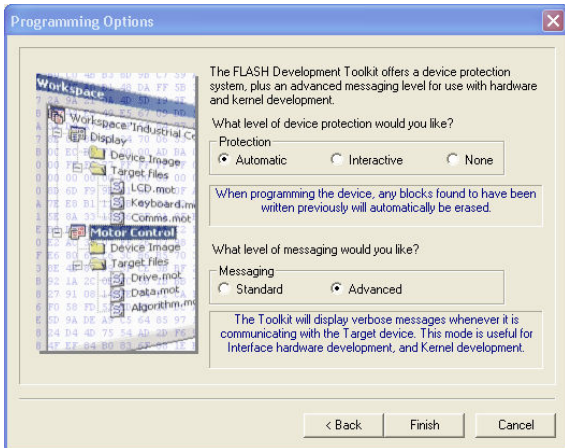
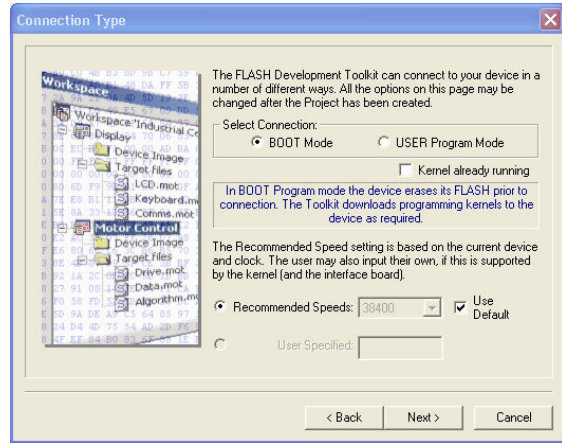

### Step 14 Programming Options

Click 'Finish'. The FDT Simple Interface screen will come up:

# Selection of file to be used & Programming Flash

## Step 14 File Selection

Click the 'User/Data Area' box  
Click the arrow  
'Browse' to where the RX55X.mot file  
is saved.  
This file will either been downloaded  
from the BBV support website or  
would have been sent be BBV  
Support.

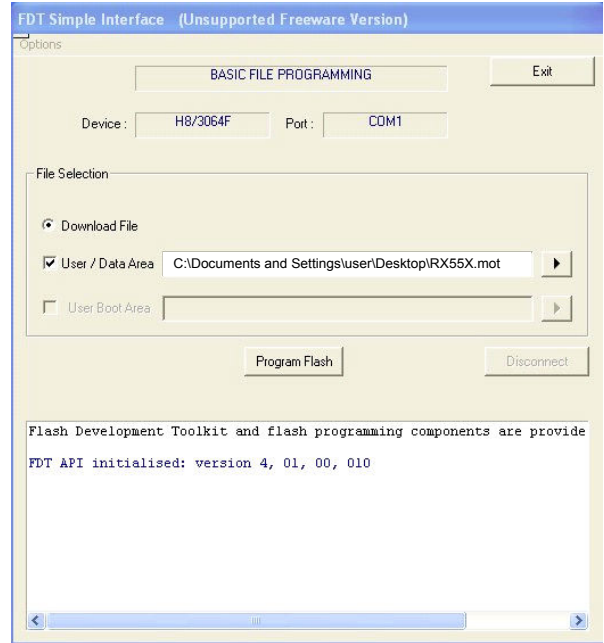

## Step 15 Ready to Program Flash

With the new file selected. It is now time  
to connect up the Receiver to the RS232  
Kit. This must be done with the Receiver  
powered down. see page 9. When  
connected as shown & Programming link  
fitted power the Receiver up.  
Then Click 'Program Flash'

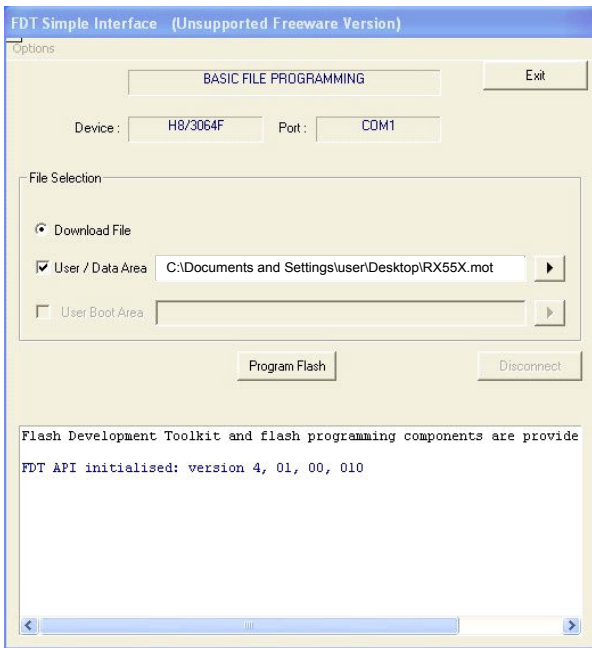

## Step 16 Image successfully written to device

With the new firmware installed, Power down the  
unit and remove the programming link. This  
Receiver is now updated.

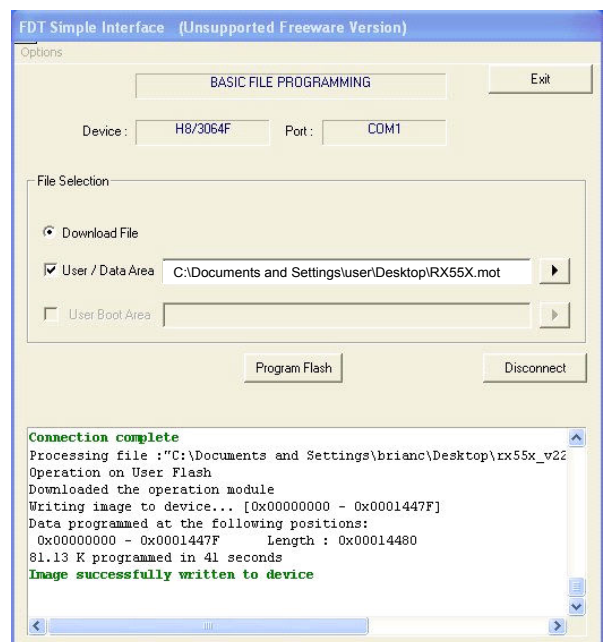

# Connection Information & Location of Programming Link

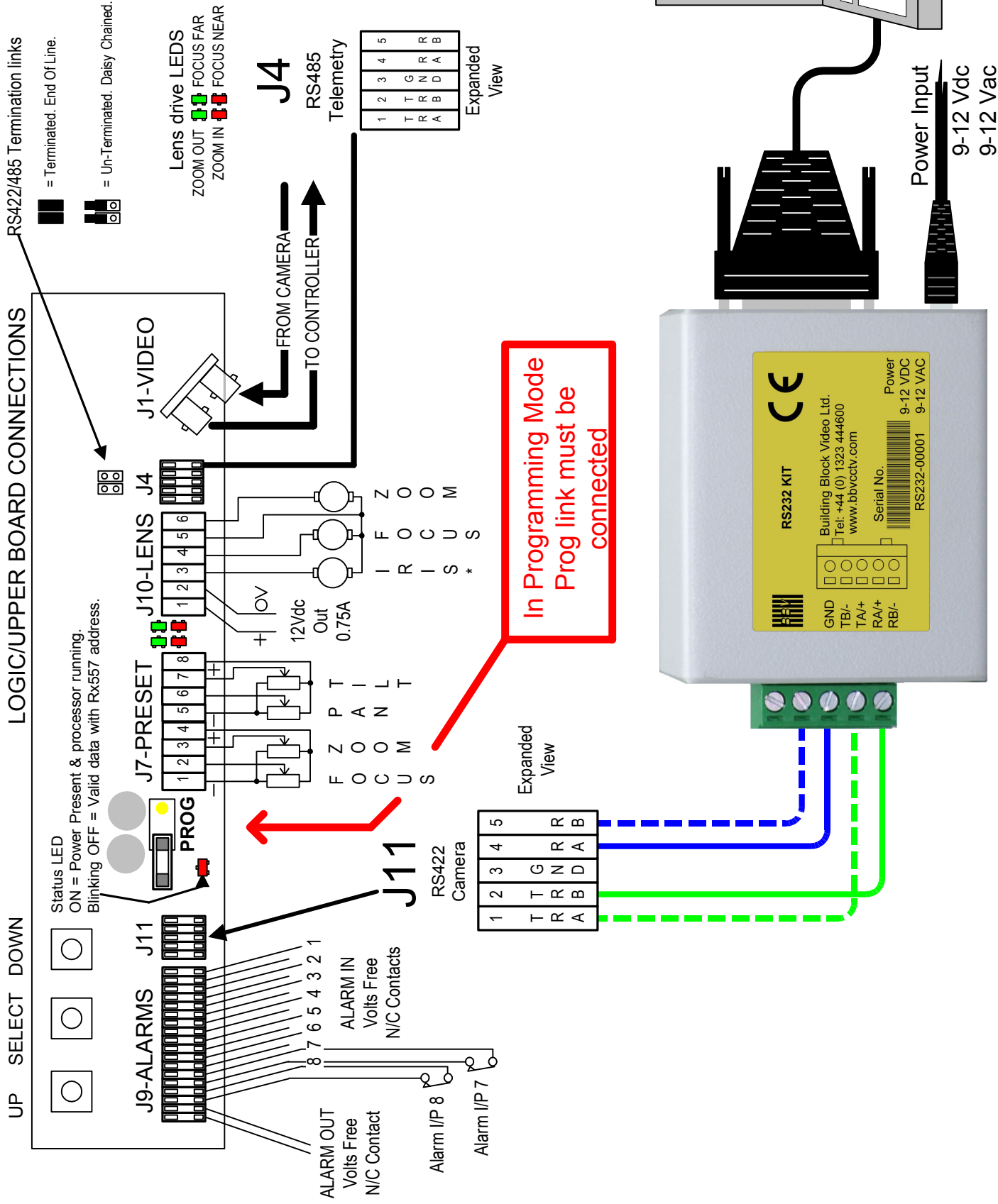





## Extend your BBV Warranty from 12 months to 3 years

As of the 1st September 2008 BBV have offered our customers the opportunity to extend the standard 12 month warranty to 3 years.

You must register for the extended warranty within 12 months of the date of manufacture.

### How to register for the 3 year warranty

Registering for the new, longer 3 year warranty term is quick and easy. Either:

Complete the warranty application card that comes in the box with your BBV product, and return it FREEPOST to BBV:



### BBV 3 Year Warranty

If this card is returned with the serial number of the product and the installation company details BBV will extend the warranty period from 12 Months to 36 Months.

Number of Units,  Start Serial No.  Final Serial No.

Contact Name: \_\_\_\_\_  
Company Name: \_\_\_\_\_  
Phone Number: \_\_\_\_\_  
Site Name: \_\_\_\_\_  
Address 1: \_\_\_\_\_  
Address 2: \_\_\_\_\_  
Address 3: \_\_\_\_\_  
Post Code: \_\_\_\_\_  
e-mail address: \_\_\_\_\_

Please could you send me information especially on:  
 Rx100s  
 Rx45x & Rx55x  
 FBM Video Matrices  
 Tx1500 Video Matrices  
 Starcard & Starcard Converters  
 BBV Quad  
 Pick A Point

Do you read  **PSI MAGAZINE SC**  
 I do not require any other further product information.

Please refer to [WWW.BBVCCTV.COM](http://WWW.BBVCCTV.COM) for terms, conditions & exclusions  
VAT Reg. No. 62758439 Registered in England No. 2852921 Registered office: 17 Apex Park Dipoles Way Hailsham East Sussex UK BN27 3JU

Or Alternatively:

Register online at [www.bbvcctv.com](http://www.bbvcctv.com)  
Simply enter your details on the 'Warranty Cover' Page

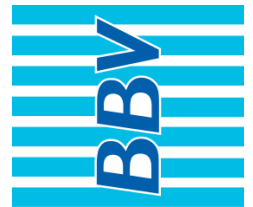

**Building Block Video Ltd**

Tel: + 44 (0) 1323 842727

Fax: + 44 (0) 1323 842728

Support: + 44 (0) 1323 444600

[www.bbvcctv.com](http://www.bbvcctv.com)

